

# MINOVA MAI SELF DRILLING SYSTEM.

# SECURING PERFORMANCE. TOGETHER.

We are an international producer of high-performance ground support products for the mining, construction and energy industries.

Our products are engineered to provide safety, efficiency and certainty to your operations wherever you are.

We can provide you with tailored solution offerings for a variety of applications whatever it takes.

We can help you increase project performance and overcome application challenges through a flexible product portfolio with a wide range of differing characteristics, wherever you go.

## OUR INDUSTRIES.

We serve the mining, construction and energy sectors.

### COAL MINING

We are a leader in providing safe environments in extremely fractured and fluid ground conditions. We understand that safety and efficiency are the key requirements of coal production.

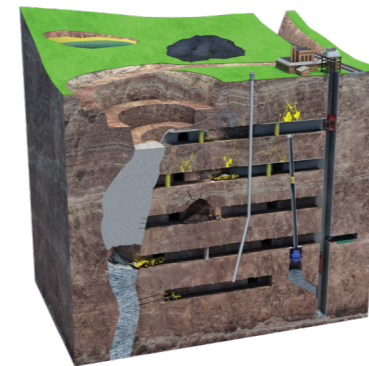

### HARD ROCK MINING

We support underground hard rock mines across the primary commodities. Our products are designed to provide safety, improve efficiency and include automated solutions.

### CONSTRUCTION

Stemming from our mining expertise, we have produced a wide range of products that are used in the construction industry. Our solutions are utilised in both above and below ground assets to secure, repair, restore and rehabilitate.

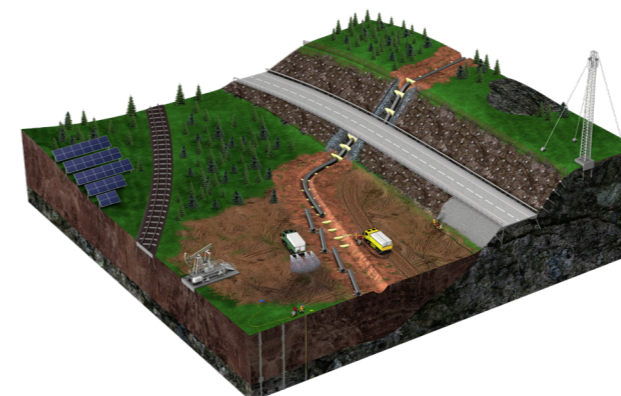

### ENERGY

We support many types of geostabilisation and structural repair projects in the energy sector. Our products and services include solutions in the oil & gas and renewable energy sectors.

# THE RIGHT REINFORCEMENT.

## INNOVATING PERFORMANCE

Our Minova MAI Self Drilling System provide you with the highest quality and support where you need it the most.

### SUPPORT WHERE YOU NEED IT

Minova offers a wide range of high-performance ground support and consolidation products and services as well as an extensive range of geotechnical solutions for applications in slope stabilisation, ground engineering, tunnelling, mining and rehabilitation.

Our know-how is the result of over 135 years of experience in the production and global supply of geotechnical products and services, providing customized solutions tailored to meet the needs of our clients.

The Self Drilling System products are manufactured by Minova MAI GmbH in Austria to meet the highest industrial standards and to provide a quality product that helps you to be safe.

The production facility is certified according to ISO 9001, ISO 14001 and ISO 45001.

### FLEXIBLE SOLUTION

Our offer includes reinforcement solutions for unstable ground conditions such as sand, gravel, silt, clay and soft to medium hard and fractured rock.

Our Self Drilling System provides an efficient and cost-effective reinforcement solution.

Our products can be used both as Self Drilling Soil and Rock Nails (SRN) or as Self Drilling Micropiles (MIP).

Product lines with and without technical approvals are available.

# THE SELF DRILLING SYSTEM.

Our Self Drilling System provides you with the highest quality and support where you need it the most.

### QUALITY ENGINEERING

The system features a hollow bars, which are used as a drill strings for drilling either with water flush, air flush or cement grout flush.

The hollow bars are fitted with a left-hand or right-hand R-thread or T-thread for easy extension and connection to conventional rock drilling equipment. The hollow bars are manufactured from seamless or welded steel tubes.

The R-thread according to ISO standards and the T-thread according to factory standard are formed in a cold rolling process. The hollow bars can be extended using couplers.

Our patented standard couplers ensure a safe connection of the hollow bars to optimally transfer the impact energy from the drill hammer to the drill bit.

A sealing rings in the centre stop minimise flush spillage during drilling.

The nuts are manufactured with a spherical cap on

at least one end to compensate for deviations of the borehole angle with respect to the plate surface.

The domed or flat plates feature a chamfered bore to ensure firm seating of the nut.

All system components are rigorously tested according to stringent factory standards and ISO 9001 to ensure that the specifications are met.

The sacrificial drill bits significantly enhance the productivity of the installation process.

In order to improve performance and cost-effectiveness, project data are being collected from around the world.

Continuous optimisation of our drill bits is a primary concern to further improve the penetration rate and bit quality while at the same time reducing manufacturing costs.

For an improved corrosion resistance, Self Drilling System components are either hot dip galvanized or fitted with a TwinCoat coating (hot-dip galvanization with an additional dual epoxy coating).

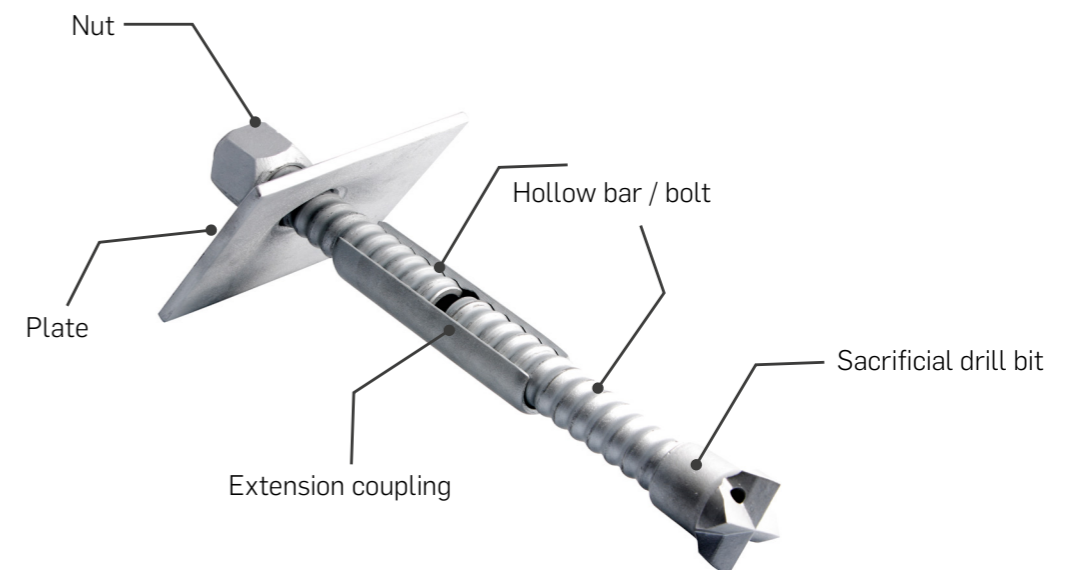

#### Legal disclaimer:

This product catalogue replaces and supersedes all prior catalogues. It provides basic information only. Technical data and information provided herein may be changed without prior notice. Minova MAI does not assume any liability for damage or losses attributed to the use of this technical data or any improper use of the products. For further information on our products please contact Minova MAI directly.

Issue 2019-02

# EASY INSTALLATION.

Our Self Drilling hollow bars offer a more efficient alternative, particularly in unstable ground conditions. The hollow bars serve as the drill string and upon completion of drilling as supporting elements.

## INSTALLATION STEPS

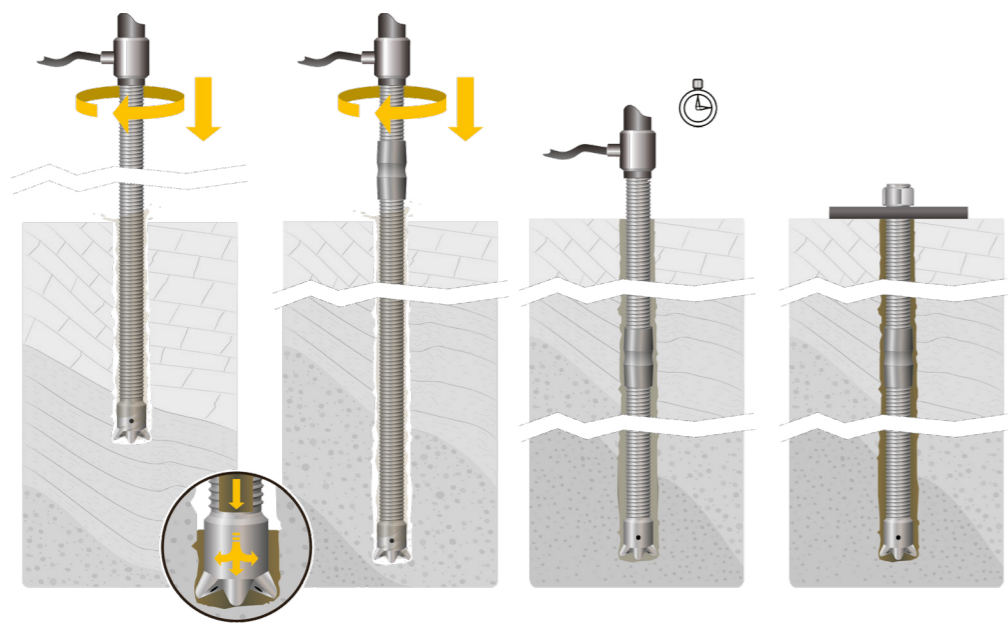

**Step 1**  
Drilling with  
grout flush,  
using a rotary  
injection adapter

**Step 2**  
Extension of the  
pile by using  
couplers

**Step 3**  
Curing of the  
grout

**Step 4**  
Once the grout  
is cured, the  
micropile  
installation is  
completed

In unstable ground conditions, conventional Self Drilling Soil and Rock Nails (SRNs) and Micropiles (MIPs) typically require a cased drilling process with retrieval of the casing during grouting. Self Drilling Systems overcome the need for cased drilling.

The hollow bars can be drilled with water flush, air flush or via simultaneous drilling and grouting.

SRNs are typically drilled using water or air flush and are grouted after installation (post grouting).

Micropiles are typically drilled using simultaneous drilling and grouting with the grout serving as the

flushing medium while simultaneously stabilizing the surrounding ground by filling voids and cracks.

After reaching the final depth, the water to cement ratio is decreased to fill the annular space between hollow bar and borehole wall for optimum load transfer.

Manual, mechanised and automated installation methods are available.

For more detailed information, see the Minova MAI Installation Guide.

# CERTIFIED QUALITY.

The Self Drilling System is available in various product lines and different technical accreditations. Separately, our production has additional certification.

## PRODUCTION CERTIFICATION: ISO CERTIFICATION

Production is certified according to:

- ISO 9001 Quality Management Systems
- ISO 14001 Environmental Management Systems
- ISO 45001 Occupational Health and Safety Management Systems

## PRODUCT CERTIFICATION: CE-CERTIFIED SYSTEMS

Our CE-certified systems come with European technical assessments.

- Soil and Rock Nails  
European Technical Assessment ETA-08/0277
- Micropiles  
European Technical Assessment ETA-11/0134

## NATIONAL TECHNICAL APPROVALS

- Soil and Rock Nails (Austria)  
BMVIT-327.120/0014-IV/IVVS2/2016
- Micropiles (Austria)  
BMVIT-327.120/0015-IV/IVVS2/2016
- Soil and Rock Nails (Germany)  
National Technical Approval for temporary soil and rock nails DLBt Z-34.713-080277
- Soil and Rock Nails (Poland)  
AT/2016-02-3278
- Micropiles (Poland)  
AT/2016-02-3278

## VALUE SYSTEMS

Our value range comes without technical approvals.

- Systems with R-threads (typically used as Soil and Rock Nails)
- Systems with T-threads (typically used as Micropiles)

# SELF DRILLING SOIL AND ROCK NAILS.

Our Self Drilling Soil and Rock Nails (SRN) consist of a self-drilling hollow bar with a rolled continuous thread as load-bearing element embedded within a grout body.

## SUPPORT WHERE YOU NEED IT

The SRNs are predominantly subjected to tensile stress, but may also be subjected to bending and shear loads.

In geotechnical engineering, they are used to stabilise natural or artificial slopes or to support structures e.g. retaining walls.

To further stabilise the surface of the slope or rock, various support systems e.g. flexible reinforcing meshes or geotextiles may be installed that are held in place by the head plates of the nails.

In underground applications, SRNs are predominantly used for forepoling, spiling, face bolting and radial bolting.

Our SRNs provide ideal solutions for weak, unstable or cracked ground conditions. SRNs are typically grouted along their entire length.

# SELF DRILLING MICROPILES.

Our Self Drilling Micropiles (MIP) consist of a self-drilling hollow bar with a rolled continuous thread as load-bearing element that is embedded within a grout body.

Micropiles are small diameter grouted piles (typically less than 300 mm in diameter) transferring compressive, tensile or alternating loads into the surrounding ground. They may also be subjected to buckling loads in particular in soft ground.

Dependant on the ground conditions, Self Drilling Micropiles are designed either as end-bearing or friction piles.

The main areas of application include:

- Foundation of new structures
- Underpinning of existing foundations
- Minimising settlements
- Buoyancy control for structures below groundwater level

Self Drilling Micropiles are typically installed via simultaneous drilling and grouting using cement grout as the flushing medium.

Particularly in cohesionless or unstable ground conditions e.g. sand, clay or gravel, this is the fastest and most efficient installation method for micropile systems.

Compared to other methods, smaller drilling equipment can be used, making Self Drilling Micropiles ideally suited for projects with limited access, confined spaces or low headroom conditions.



# CORROSION PROTECTION.

We offer a suite of complimentary products to help your bolting needs.

## TECHNICALLY APPROVED

The required service life is an important design criterion.

The system can be used for temporary (up to 2 years) and permanent applications (up to 50 years and beyond).

In accordance with EN 14199 and EN 14490, Minova MAI provides products for the design of permanent elements.

In line to the above mentioned standards, the loss in cross sectional area due to corrosion of the hollow bars and components is taken into account.

For more detailed information please refer to the Minova MAI Design Guide.

The service life of the system is closely linked to ground conditions (soil corrosiveness) and the design load.

The Minova MAI Self Drilling System is available in:

- Bright (uncoated) steel
- Hot dip galvanized according to EN ISO 1461
- Hot dip galvanized according to EN ISO 1461 with a double layer of epoxy coating on top called TwinCoat

## TWINCOAT™ PROCESS

Our TwinCoat process is available for our SDA anchors.

The coating process is comprised of a hot dip galvanisation in accordance to EN ISO 1461 and Epoxy coating in accordance with ISO 2178.

The TwinCoat process is tested for suitability in accordance with corrosion category C5-M and Im3 (durability range according to ISO 12944-2).

Testing performed by OFI (Austria).

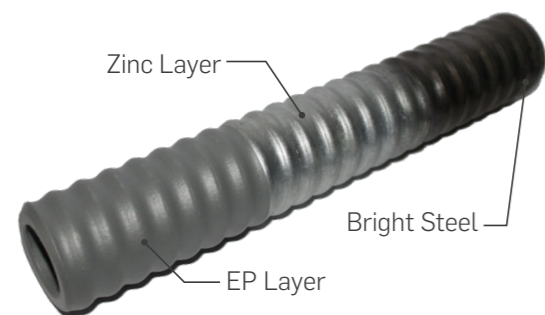

## LOSS IN CROSS SECTIONAL AREA DUE TO CORROSION

Type	Parameter	Sacrificial corrosion [mm]															
		0	0.05	0.1	0.15	0.2	0.3	0.4	0.45	0.5	0.6	0.7	0.8	0.9	1.0	1.4	1.7
R25N	%	0	2	3	4	5	8	10	12	13	15	18	21	23	25	36	44
R32L	%	0	2	3	4	6	8	11	13	14	17	19	23	25	27	39	48
R32N	%	0	1	2	3	5	7	9	10	11	14	16	18	21	22	32	39
R32S	%	0	1	2	3	4	6	8	9	9	11	13	15	17	18	26	32
R38N	%	0	1	2	2	3	5	6	7	8	9	11	13	14	16	22	27
R51L	%	0	1	2	3	3	5	7	8	8	10	12	14	16	17	25	30
R51N	%	0	1	1	2	3	4	6	7	7	8	10	12	14	14	21	25
T51S	%	0	1	1	2	2	4	5	5	6	7	8	10	11	12	17	20
T63N	%	0	1	1	2	2	4	5	6	6	7	8	9	10	12	16	20
T76N	%	0	1	1	2	3	4	5	6	6	8	10	10	11	13	18	22
T76S	%	0	1	1	2	2	3	4	5	5	6	7	8	9	10	14	17
T111L	%	0	1	1	2	2	3	4	5	5	7	8	9	10	11	15	19
T111N	%	0	0	1	1	2	2	3	4	4	5	6	6	7	8	11	14

Years	Steel	Sacrificial corrosion [mm]		
		l	m	h
2	A	0	0	0.2
	B	0	0	0
7	A	0.15	0.2	0.5
	B	0	0	0.3
10	A	0.15	0.2	-
	B	0	0	-
20	A	0.2	0.4	-
	B	0	0.1	-
30	A	0.3	0.6	-
	B	0	0.3	-
40	A	0.4	0.7	-
	B	0.1	0.45	-
50	A	0.5	0.9	-
	B	0.2	0.6	-
100	A	0.8	1.7	-
	B	0.4	1.4	-

Additional information (residual load capacity due to corrosion for bright and galvanized systems up to 100 years of service life) is available upon request.

Legend	
Soil aggressiveness	Steel
l = low	A = bright (uncoated)
m = medium	B = galvanized, average thickness min. 85 µm
h = high	

The indications given on the working life cannot be interpreted as a guarantee given by the manufacturer but are to be regarded only as a means for choosing the appropriate products in relation to the expected economically reasonable working life of the works.

# CE-CERTIFIED LINE.

For those who require the highest quality and dependability.

## TECHNICALLY APPROVED

The CE-certified line is based on the European Technical Assessments for Soil and Rock Nails (ETA-08/277) and Micropiles (ETA-11/0134).

In addition, a number of national technical approvals have also been granted.

The CE-certified line is produced in compliance with the regulations of ISO 9001.

The couplers and nuts transfer the loads specified for the respective system.

## HOLLOW BARS

The system consists of one or several coupled hollow bars for drilling with water or air flush or for simultaneous drilling and grouting.

The hollow bar features a left-hand or right-hand R-thread (rope thread) or T-thread (trapezoidal thread) for easy extension and connection to all conventional drill rigs. It is manufactured from seamless or welded steel tubes.

The R-thread according to ISO standards and T-thread according to factory standard are both formed in a cold rolling process.

Only seamless tubes are used. We purchase the tubes from European suppliers approved according to ETAG 013.

## EXTENSION COUPLERS

The couplers are used to extend the hollow bars. The required length of the load-bearing element can thus be achieved also in cases of limited feed length of the drill rig or low headroom conditions.

All couplers are designed to safely transfer the specified system load, with the faces of the hollow bars bearing against each other to ensure safe energy transfer between the hollow bars and the drill bit without affecting the couplers mechanically.

Only seamless tubes are used. We purchase the tubes from European suppliers approved according to ETAG 013. The couplers are fitted with an R-thread or T-thread to ensure safe connection of the hollow bars.

## PLATES

The steel plates feature a chamfered bore allowing an angle of deviation of 5 degrees in all directions.

The technical approvals prescribe the use of specific plates for each type of hollow bar dependent on its use as Soil and Rock Nails or Micropiles.

## NUTS

All nuts are designed to transfer the load from the plate into the hollow bar. They feature a spherical cap on at least one end to compensate for angle deviations. All nuts are designed to ensure safe transfer of the specified system load.

The technical approvals prescribe the use of specific nuts for each type of hollow bar. The nuts feature an R-thread or T-thread to securely connect to the hollow bars.

## NAIL AND PILE NECK PROTECTION TUBE

Protection tubes for soil and rock nails (plastic tubes) and pile neck protection tubes (plastic or steel tubes) are available upon request.

## Minova MAI R25 CE-line

HOLLOW BARS				
Item	Type	Length (other lengths on request)		
		2m	3m	4m
Hollow bars bright	R25N	9899710316	9899702467	9899702466
Hollow bars galvanized	R25N	9899710317	9899710319	9899710320

COMPONENTS		
Item	Type	Soil Nails
Couplers bright	R25N, L=150mm	9899702471
Couplers galvanized	R25N; L=150mm	9899102147
Nuts bright	Load bearing	9899702470
Nuts galvanized	Load bearing	9899710322
Plates bright	R25N domed 150 x 150 x 8, ø30mm	9899710323
Plates galvanized	R25N domed 150 x 150 x 8, ø35mm	9899710324

DRILL BITS		
Item	Type (other types on request)	Soil Nails
Drill bits	R25/ø51mm/X	9899100778
	R25/ø51mm/EX	9899101506

## Minova MAI R32 CE-line

HOLLOW BARS				
Item	Type	Length (other lengths on request)		
		2m	3m	4m
Hollow bars bright	R32L	9899702465	9899702463	9899702461
	R32N	9899702459	9899702457	9899702455
	R32S	9899702453	9899702451	9899702449
Hollow bars galvanized	R32L	9899702464	9899702462	9899702460
	R32N	9899702458	9899702456	9899702454
	R32S	9899702452	9899702450	9899702448

COMPONENTS				
Item	Type	Soil Nails	Micropiles	
Couplers bright	R32 L & N, L=145mm		9899702469	
	R32S, L=190mm		9899702468	
Couplers galvanized	R32 L & N & S, L=160mm		9899702427	
Nuts bright	Load bearing		9899702474	
	Counter nuts		9899710863	
Nuts galvanized	Load bearing		9899702423	
Plates bright	R32L domed 150 x 150 x 8, ø35mm	9899702479		
	R32N domed 200 x 200 x 8, ø35mm	9899702382		
	R32S domed 200 x 200 x 10, ø35mm	9899702478		
	R32N flat 95 x 95 x 25, ø35mm, with chamfer		9899702322	
	R32S flat 120 x 120 x 30, ø35mm, with chamfer		9899702327	
Plates galvanized	R32L domed 150 x 150 x 8, ø35mm	9899702481		
	R32N domed 200 x 200 x 8, ø35mm	9899702483		
	R32S domed 200 x 200 x 10, ø35mm	9899702482		
	R32N flat 95 x 95 x 25, ø35mm, with chamfer		9899702361	
	R32S flat 120 x 120 x 30, ø35mm, with chamfer		9899702363	
Protection tube	steel or plastic		on request	

DRILL BITS				
Item	Type (other types on request)	Soil Nails	Micropiles	
Drill bits	R32/ø76/EX		9899101267	
	R32/ø90/EX		9899700569	
	R32/ø76/clay		9899702772	
	R32/ø90/clay		9899702773	
	R32/ø110/clay		9899702634	
	R32/ø76/ES-F		9899710596	
	R32/ø76/ESS-F		9899710515	

## Minova MAI R38 CE-line

HOLLOW BARS				
Item	Type	Length (other lengths on request)		
		2m	3m	4m
Hollow bars bright	R38N	9899702447	9899702445	9899702443
Hollow bars galvanized	R38N	9899702446	9899702444	9899702442

COMPONENTS				
Item	Type	Soil Nails	Micropiles	
Couplers bright	R38N, L=220mm		9899702477	
Couplers galvanized	R38N, L=220mm		9899702426	
Nuts bright	Load bearing		9899702473	
	Lock nut		9899710864	
Nuts galvanized	Load bearing		9899702422	
Plates bright	R38N domed 200 x 200 x 12, ø41mm	9899702480		
	R38N flat 140 x 140 x 35, ø41mm, with chamfer		9899702329	
Plates galvanized	R38N domed 200 x 200 x 12, ø41mm	9899702484		
	R38N flat 140 x 140 x 35, ø41mm, with chamfer		9899702364	
Protection tube	steel or plastic		on request	

DRILL BITS				
Item	Type (other types on request)	Soil Nails	Micropiles	
Drill bits	R38/ø110/XX		9899102543	
	R38/ø115/XX		9899700399	
	R38/ø130/XX		9899703259	
	R38/ø150/XX		9899700085	
	R38/ø200/XX		9899703281	
	R38/ø110/clay		9899702774	
	R38/ø115/EXX		9899703304	
	R38/ø130/clay		9899702633	
	R38/ø76/EX		9899100782	
	R38/ø76/EY		9899151017	
	R38/ø76/EYY		9899102623	
	R38/ø90/EX		9899150016	
	R38/ø90/EXX		9899703258	
	R38/ø90/EYY		9899150041	
	R38/ø90/clay		9899702678	
	R38/ø115/ESS-D		9899150622	
	R38/ø76/ES-F		9899150028	
	R38/ø76/ESS-F		9899150029	
	R38/ø90/ES-F		9899710619	
	R38/ø90/ESS-F		9899710620	



## Minova MAI R51 CE-line

HOLLOW BARS				
Item	Type	Length (other lengths on request)		
		2m	3m	4m
Hollow bars bright	R51L	9899702441	9899702439	9899702437
	R51N	9899702434	9899702432	9899702430
Hollow bars galvanized	R51L	9899702440	9899702438	9899702436
	R51N	9899702433	9899702431	9899702429

COMPONENTS				
Item	Type	Soil Nails	Micropiles	
Couplers bright	R51L, L=170mm		9899702726	
	R51N, L=220mm		9899702475	
Couplers galvanized	R51 L & N, L=200mm		9899702424	
Nuts bright	Load bearing		9899711153	
	Lock nut		9899710865	
Nuts galvanized	Load bearing		9899711154	
Plates bright	R51L flat 150 x 150 x 40, ø56mm, with chamfer		9899702331	
	R51N flat 180 x 180 x 45, ø56mm, with chamfer		9899702346	
Plates galvanized	R51L flat 150 x 150 x 40, ø56mm, with chamfer		9899702365	
	R51N flat 180 x 180 x 45, ø56mm, with chamfer		9899702366	
Protection tube	steel or plastic		on request	

DRILL BITS				
Item	Type (other types on request)	Soil Nails	Micropiles	
Drill bits	R51/ø100/XX		9899702977	
	R51/ø110/XX		9899150042	
	R51/ø120/XX		9899700436	
	R51/ø130/XX		9899700066	
	R51/ø90/XX		9899702795	
	R51/ø170/XX		9899700456	
	R51/ø175/XX		9899700063	
	R51/ø183/XX		9899700675	
	R51/ø200/XX		9899702974	
	R51/ø100/EX		9899702318	
	R51/ø115/EX		9899711077	
	R51/ø115/EXX		9899711043	
	R51/ø130/EX		9899703260	
	R51/ø130/EXX		9899703305	

## Minova MAI R51 CE-line

DRILL BITS (CONTINUED)				
Item	Type (other types on request)	Soil Nails	Micropiles	
Drill bits	R51/ø200/clay		9899703308	
	R51/ø150/clay		9899702586	
	R51/ø175/clay		9899702775	
	R51/ø90/EXX		9899703011	
	R51/ø90/EY		9899702367	
	R51/ø90/clay		9899702756	
	R51/ø100/ES-F		9899150022	
	R51/ø100/ESS-F		9899150753	
	R51/ø115/ES-D		9899150892	
	R51/ø115/ESS-D		9899150059	

## Minova MAI T51S CE-line

HOLLOW BARS				
Item	Type	Length (other lengths on request)		
		2m	3m	4m
Hollow bars bright	T51S	9899711162	9899711163	9899711164
Hollow bars galvanized	T51S	9899711166	9899711165	9899711177

COMPONENTS		
Item	Type	Micropiles
Couplers bright	T51S, L=160mm	9899711169
Couplers galvanized	T51S, L=160mm	9899711170
Nuts bright	Load bearing	9899711171
	Lock nut	9899711167
Nuts galvanized	Load bearing	9899711172
	Lock nut	9899711168
Plate bright	T51S flat 200 x 200 x 50, ø60mm, with chamfer	9899711160
Plate galvanized	T51S flat 200 x 200 x 50, ø60mm, with chamfer	9899711161

DRILL BITS		
Item	Type (other types on request)	Micropiles
Drill bits	T51/ø175/EX	9899710504
	T51/ø175/clay	9899710505
	T51/ø115/EX	9899710816
	T51/ø115/ESS-F	9899710817
	T51/ø130/clay	9899710818

## Minova MAI T63N CE-line

HOLLOW BARS				
Item	Type	Length (other lengths on request)		
		2m	3m	4m
Hollow bars bright	T63N	9899711174	9899711173	9899711175
Hollow bars galvanized	T63N	9899711178	9899711176	9899711184

COMPONENTS		
Item	Type	Micropiles
Couplers bright	T63N, L=180mm	9899711180
Couplers galvanized	T63N, L=180mm	9899711181
Nuts bright	Load bearing	9899711182
	Lock nut	9899711185
Nuts galvanized	Load bearing	9899711183
	Lock nut	9899711259
Plate bright	T63N flat 230 x 230 x 55, ø80mm, with chamfer	9899711186
Plate galvanized	T63N flat 230 x 230 x 55, ø80mm, with chamfer	9899711187

DRILL BITS		
Item	Type (other type on request)	Micropiles
Drill bits	T63/ø115/EX	9899711096
	T63/ø115/ESS-F	9899711097
	T63/ø130/clay	9899711098

## Minova MAI T76 CE-line

HOLLOW BARS				
Item	Type	Length (other lengths on request)		
		2m	3m	4m
Hollow bars bright	T76N	9899710129	9899710130	9899710131
	T76S	9899710133	9899710134	9899710135
Hollow bars galvanized	T76N	9899710137	9899710138	9899710139
	T76S	9899710140	9899710141	9899710142

COMPONENTS		
Item	Type	Micropiles
Couplers bright	T76, L=220mm	9899710143
Couplers galvanized	T76, L=220mm	9899710144
Nuts bright	Load bearing	9899710145
	Lock nut	9899710866
Nuts galvanized	Load bearing	9899710146
Plates bright	T76 flat 250 x 250 x 60, ø90mm, with chamfer	9899710147
Plates galvanized	T76 flat 250 x 250 x 60, ø90mm, with chamfer	9899710148
Protection tube	steel or plastic	on request

DRILL BITS		
Item	Type (other types on request)	Micropiles
Drill bits	T76/ø130/XX	9899700003
	T76/ø145/XX	9899700493
	T76/ø175/XX	9899152281
	T76/ø200/XX	9899700094
	T76/ø280/XX	9899701526
	T76/ø300/XX	9899710003
	T76/ø130/EX	9899700054
	T76/ø130/clay	9899702749
	T76/ø150/EX	9899700473
	T76/ø150/EXX	9899703306
	T76/ø150/clay	9899702743
	T76/ø175/clay	9899702744
	T76/ø200/EXX	9899703307
	T76/ø200/clay	9899702750
	T76/ø120/ESS-F	9899700093

## Minova MAI T111 CE-line

HOLLOW BARS				
Item	Type	Length (other lengths on request)		
		2m	3m	4m
Hollow bars bright	T111L	9899710149	9899710150	9899710151
	T111N	9899710156	9899710153	9899710154
Hollow bars galvanized	T111L	9899710173	9899710157	9899710174
	T111N	9899710175	9899710158	9899710176

COMPONENTS		
Item	Type	Micropiles
Couplers bright	T111, L=250mm	9899710159
Couplers galvanized	T111, L=250mm	9899710160
Nuts bright	Load bearing	9899710161
	Lock nut	9899710867
Nuts galvanized	Load bearing	9899710162
Plates bright	T111L flat 300 x 300 x 80, ø130mm, with chamfer	9899710163
	T111N flat 350 x 350 x 90, ø130mm, with chamfer	9899710165
Plates galvanized	T111L flat 300 x 300 x 80, ø130mm, with chamfer	9899710164
	T111N flat 350 x 350 x 90, ø130mm, with chamfer	9899710166
Protection tube	steel or plastic	on request

DRILL BITS		
Item	Type (other types on request)	Micropiles
Drill bits	T111/ø175/XX	9899710294
	T111/ø220/EX-4	9899701780
	T111/ø220/EX-5	9899702412
	T111/ø220/clay	9899701779
	T111/ø170/ESS-F	9899701781

# VALUE LINE.

The Value line meets your requirements at a reasonable price.

## ISO 9001

The Value line does not have technical approvals. The Value line is produced in compliance with the regulations of ISO 9001. The couplers and nuts transfer the loads specified for the respective system.

## HOLLOW BARS

The system consists of one or several coupled hollow bars for drilling with water or air flush or for simultaneous drilling and grouting.

The hollow bar features a left-hand or right-hand R-thread (rope thread) or T-thread (trapezoidal thread) for easy extension and connection to all conventional drill rigs. It is manufactured from seamless or welded steel tubes.

The R-thread according to ISO standards and T-thread according to factory standard are both formed in a cold rolling process.

For the Value line, seamless or welded tubes are used. The material is purchased exclusively from carefully selected suppliers with proven expertise in quality.

## EXTENSION COUPLERS

The couplers are used to extend the hollow bars. The required length of the load-bearing element can thus be achieved also in cases of limited feed length of the drill rig or low headroom conditions.

All couplers are designed to safely transfer the specified system load, with the faces of the hollow bars bearing against each other to ensure safe energy transfer between the hollow bars and the drill bit without affecting the couplers mechanically.

For the Value-line, seamless or welded tubes are used. The material is purchased exclusively from carefully selected suppliers with proven expertise in quality.

For the Value line, you can choose from the two options:

- Standard couplers with an R-thread or T-thread dependent on the thread of the bar used
- A new thread design allows to significantly reduce the length of the coupler for R-threads thus offering improved economy without impairing the specified system performance (LC coupler)

## PLATES

The steel plates feature a chamfered bore allowing an angle of deviation of five degrees in all directions.

The designer/customer is free to choose from among a variety of plates dependent on the requirements of the specific project.

## NUTS

All nuts are designed to transfer the load from the plate into the hollow bar. They feature a spherical cap on at least one end to compensate for angle deviations. All nuts are designed to ensure safe transfer of the specified system load.

The material is purchased exclusively from carefully selected suppliers with proven expertise in quality. For the Standard-line, the designer/customer is free to choose between two options:

- Standard nuts with R-thread or T-thread dependent on the thread of the bar used
- A new thread design enables nuts for R-threads to be produced more economically without impairing the specified system performance (LC nut)

## NAIL AND PILE NECK PROTECTION TUBE

Protection tubes for soil and rock nails (plastic tubes) and pile neck protection tubes (plastic or steel tubes) are available upon request.

## Minova MAI R25 Value line

HOLLOW BARS				
Item	Type	Length (other lengths on request)		
		2m	3m	4m
Hollow bars bright	R25N	9899100751	9899100750	9899100752
Hollow bars galvanized	R25N	9899101130	9899101131	9899101132

COMPONENTS		
Item	Type	Soil Nails
Couplers bright	R25N, L=150mm	9899700032
Couplers galvanized	R25N, L=150mm	9899101136
Couplers LC	R25N, L=90mm	9899710441
Nuts bright	Load bearing	9899100762
Nuts galvanized	Load bearing	9899101136
Plates bright	R25N domed 150 x 150 x 8, ø30mm	9899100795
Plates galvanized	R25N domed 150 x 150 x 8, ø30mm	9899101137

DRILL BITS		
Item	Type (other types on request)	Soil Nails
Drill bits	R25/ø51mm/X	9899100778
	R25/ø42mm/EX	9899100780
	R25/ø51mm/EX	9899101506
	R25/ø42mm/EXX	9899101606
	R25/ø42mm/EC	9899710464
	R25/ø42mm/ECC	9899702772

## Minova MAI R32 Value line

HOLLOW BARS				
Item	Type	Length (other lengths on request)		
		2m	3m	4m
Hollow bars bright	R32L	9899700050	9899700049	9899700051
	R32N	9899100754	9899100755	9899100756
	R32S	9899100758	9899100759	9899100760
Hollow bars galvanized	R32L	9899701377	9899701379	9899701381
	R32N	9899101160	9899101852	9899102188
	R32S	9899101367	9899101366	9899102443
Hollow bars TwinCoat	R32N	9899710520	9899710521	9899710522
	R2S	9899710527	9899710528	9899710529

COMPONENTS				
Item	Type	Soil Nails	Micropiles	
Couplers bright	R32 L & N, L=145mm		9899700083	
	R32S, L=190mm		9899700078	
Couplers galvanized	R32 L & N & S, L=160mm		9899150115	
Couplers TwinCoat	R32 L & N & S, L=160mm		9899710569	
Couplers LC	R32 L & N, L=90mm		9899710328	
	R32S, L=110mm		9899710329	
Nuts bright	Load bearing		9899710325	
	Lock nut		9899711188	
Nuts galvanized	Load bearing		9899101161	
Nuts LC	Load bearing		9899710325	
Plates bright	R32L domed 150 x 150 x 8, ø35mm	9899702522		
	R32N domed 200 x 200 x 8, ø35mm	9899702521		
	R32S domed 200 x 200 x 10, ø35mm	9899100798		
	R32N flat 95 x 95 x 25, ø35mm, with chamfer		9899702532	
	R32S flat 120 x 120 x 30, ø35mm, with chamfer		9899702533	
	R32L domed 150 x 150 x 8, ø35mm	9899702518		
Plates galvanized	R32N domed 200 x 200 x 8, ø35mm	9899702519		
	R32S domed 200 x 200 x 10, ø35mm	9899101163		
	R32N flat 95 x 95 x 25, ø35mm, with chamfer		9899702535	
	R32S flat 120 x 120 x 30, ø35mm, with chamfer		9899702536	

## Minova MAI R32 Value line

DRILL BITS			
Item	Type (other types on request)	Soil Nails	Micropiles
Drill bits	R32/ø51/X		9899100779
	R32/ø51/EX		9899100781
	R32/ø76/EX		9899101267
	R32/ø90/EX		9899700569
	R32/ø51/EXX		9899700409
	R32/ø76/clay		9899702772
	R32/ø90/clay		9899702773
	R32/ø110/clay		9899702634
	R32/ø51/EC		9899150083
	R32/ø51/ECC		9899150752
	R32/ø51/ES-F		9899150030
	R32/ø51/ESS-F		9899150031
	R32/ø76/ES-F		9899710596
	R32/ø76/ESS-F		9899710515

## Minova MAI R38 Value line

HOLLOW BARS				
Item	Type	Length (other lengths on request)		
		2m	3m	4m
Hollow bars bright	R38N	9899100763	9899100764	9899100765
Hollow bars galvanized	R38N	9899102665	9899102043	9899102666
Hollow bars TwinCoat	R38N	9899710546	9899710547	9899710548

COMPONENTS				
Item	Type	Soil Nails	Micropiles	
Couplers bright	R38N, L=220mm		9899700034	
Couplers galvanized	R38N, L=220mm		9899102042	
Couplers TwinCoat	R38N, L=220mm		9899710549	
Couplers LC	R38N, L=100mm		9899710327	
Nuts bright	Load bearing		9899710326	
	Lock nut		9899711189	
Nuts galvanized	Load bearing		9899101981	
Nuts LC	Load bearing		9899710326	
Plates bright	R38N domed 200 x 200 x 12, ø41mm	9899100800		
	R38N flat 140 x 140 x 35, ø41mm, with chamfer		9899702534	
Plates galvanized	R38N domed 200 x 200 x 12, ø41mm	9899101980		
	R38N flat 140 x 140 x 35, ø41mm, with chamfer		9899702537	

DRILL BITS				
Item	Type (other types on request)	Soil Nails	Micropiles	
Drill bits	R38/ø110/XX		9899102543	
	R38/ø115/XX		9899700399	
	R38/ø130/XX		9899703259	
	R38/ø150/XX		9899700085	
	R38/ø200/XX		9899703281	
	R38/ø110/clay		9899702774	
	R38/ø115/EXX		9899703304	
	R38/ø130/clay		9899702633	
	R38/ø76/EX		9899100782	
	R38/ø76/EY		9899151017	
	R38/ø76/EYY		9899102623	
	R38/ø90/EX		9899150016	
	R38/ø90/EXX		9899703258	
	R38/ø90/EYY		9899150041	
	R38/ø90/clay		9899702678	
	R38/ø76/ES-F		9899150028	
	R38/ø76/ESS-F		9899150029	
	R38/ø90/ES-F		9899710619	
	R38/ø90/ESS-F		9899710620	
	R38/ø115/ESS-D		9899150622	

## Minova MAI R51 Value line

HOLLOW BARS				
Item	Type	Length (other lengths on request)		
		2m	3m	4m
Hollow bars bright	R51L	9899150057	9899150052	9899150064
	R51N	9899150062	9899150061	9899150035
Hollow bars galvanized	R51L	9899700041	9899150988	9899700042
	R51N	9899151312	9899150989	9899700045
Hollow bars TwinCoat	R51L	9899710570	9899710561	9899710562
	R51N	9899710375	9899710370	9899710433

COMPONENTS				
Item	Type	Soil Nails	Micropiles	
Couplers bright	R51L, L=170mm		9899700035	
	R51N, L=220mm		9899700036	
Couplers galvanized	R51 L & N, L=200mm		9899150985	
Couplers TwinCoat	R51 L & N, L=200mm		9899710371	
Couplers LC	R51L, L=120mm		9899710412	
	R51N, L=140mm		9899710413	
Nuts bright	Load bearing		9899711137	
	Lock nut		9899711190	
Nuts galvanized	Load bearing		9899711142	
Nuts LC	Load bearing		9899710523	
Plates bright	R51L flat 150 x 150 x 40, ø56mm, with chamfer		9899702524	
	R51N flat 180 x 180 x 45, ø56mm, with chamfer		9899702525	
	R51N flat 250 x 250 x 40, ø60mm		9899150097	
Plates galvanized	R51L flat 150 x 150 x 40, ø56mm, with chamfer		9899702526	
	R51N flat 180 x 180 x 45, ø56mm, with chamfer		9899702527	

DRILL BITS				
Item	Type (other types on request)	Soil Nails	Micropiles	
Drill bits	R51/ø100/XX		9899702977	
	R51/ø110/XX		9899150042	
	R51/ø120/XX		9899700436	
	R51/ø130/XX		9899700066	
	R51/ø76/XX		9899702095	
	R51/ø90/XX		9899702795	
	R51/ø170/XX		9899700456	
	R51/ø175/XX		9899700063	

## Minova MAI R51 Value line

DRILL BITS (CONTINUED)			
Item	Type (other types on request)	Soil Nails	Micropiles
Drill bits	R51/ø183/XX		9899700675
	R51/ø200/XX		9899702974
	R51/ø100/EX		9899702318
	R51/ø115/EX		9899711077
	R51/ø115/EXX		9899711043
	R51/ø130/EX		9899703260
	R51/ø130/EXX		9899703305
	R51/ø200/clay		9899703308
	R51/ø150/clay		9899702586
	R51/ø175/clay		9899702775
	R51/ø76/clay		9899702585
	R51/ø90/EXX		9899703011
	R51/ø90/EY		9899702367
	R51/ø90/clay		9899702756
	R51/ø100/ES-F		9899150022
	R51/ø100/ESS-F		9899150753
	R51/ø115/ES-D		9899150892
	R51/ø115/ESS-D		9899150059
	R51/ø76/ESS-F		9899701917

## Minova MAI T51S Value line

HOLLOW BARS				
Item	Type	Length (other lengths on request)		
		2m	3m	4m
Hollow bars bright	T51S	9899710582	9899710581	9899710719
Hollow bars galvanized	T51S	9899710750	9899710752	9899710753
Hollow bars TwinCoat	T51S	9899710754	9899710755	9899710756

COMPONENTS			
Item	Type	Micropiles	
Couplers bright	T51S, L=160mm	9899710580	
Couplers galvanized	T51S, L=160mm	9899710757	
Couplers TwinCoat	T51S, L=160mm	9899710763	
Nuts bright	Load bearing	9899710724	
	Lock nut	9899710748	
Nuts galvanized	Load bearing	9899710760	
Plates bright	T51S flat 200 x 200 x 50, ø60mm	9899710556	
	T51S flat 200 x 200 x 50, ø60mm, with chamfer	9899710725	
Plates galvanized	T51S flat 200 x 200 x 50, ø60mm	9899710765	
	T51S flat 200 x 200 x 50, ø60mm, with chamfer	9899710767	

DRILL BITS			
Item	Type (other types on request)	Micropiles	
Drill bits	T51/ø175/EX	9899710504	
	T51/ø175/clay	9899710505	
	T51/ø115/EX	9899710816	
	T51/ø115/ESS-F	9899710817	
	T51/ø130/clay	9899710818	

## Minova MAI T63N Value line

HOLLOW BARS				
Item	Type	Length (other lengths on request)		
		2m	3m	4m
Hollow bars bright	T63N	9899710906	9899710873	9899710954
Hollow bars galvanized	T63N	9899710971	9899710970	9899710972
Hollow bars TwinCoat	T63N	9899710977	9899710978	9899710979

COMPONENTS		
Item	Type	Micropiles
Couplers bright	T63N, L=180mm	9899710876
Couplers galvanized	T63N, L=180mm	9899710984
Couplers TwinCoat	T63N, L=180mm	9899710985
Nuts bright	Load bearing	9899710874
	Lock nut	9899710875
Nuts galvanized	Load bearing	9899710982
Plates bright	T63N flat 230 x 230 x 55, ø80mm	9899710952
	T63N flat 230 x 230 x 55, ø80mm, with chamfer	9899710884
Plates galvanized	T63N flat 230 x 230 x 55, ø80mm	9899710951
	T63N flat 230 x 230 x 55, ø80mm, with chamfer	9899710953

DRILL BITS		
Item	Type (other type on request)	Micropiles
Drill bits	T63/ø115/EX	9899711096
	T63/ø115/ESS-F	9899711097
	T63/ø130/clay	9899711098

## Minova MAI T76 Value line

HOLLOW BARS				
Item	Type	Length (other lengths on request)		
		2m	3m	4m
Hollow bars bright	T76N	9899150644	9899150650	9899150651
	T76S	9899151102	9899151103	9899151104
Hollow bars galvanized	T76N	9899700319	9899700320	9899700321
	T76S	9899700323	9899700324	9899700202
Hollow bars TwinCoat	T76N	9899710518	9899710343	9899710492
	T76S	9899710571	9899710563	9899710564

COMPONENTS		
Item	Type	Micropiles
Couplers bright	T76, L=220mm	9899150646
Couplers galvanized	T76, L=220mm	9899700325
Couplers TwinCoat	T76, L=220mm	9899710344
Nuts bright	Load bearing	9899150645
	Lock nut	9899711191
Nuts galvanized	Load bearing	9899700326
Plates bright	T76 flat 250 x 250 x 60, ø90mm, with chamfer	9899151047
Plates galvanized	T76 flat 250 x 250 x 60, ø90mm, with chamfer	9899703288

DRILL BITS		
Item	Type (other types on request)	Micropiles
Drill bits	T76/ø130/XX	9899700003
	T76/ø145/XX	9899700493
	T76/ø175/XX	9899152281
	T76/ø200/XX	9899700094
	T76/ø280/XX	9899701526
	T76/ø300/XX	9899710003
	T76/ø130/EX	9899700054
	T76/ø130/clay	9899702749
	T76/ø150/EX	9899700473
	T76/ø150/EXX	9899703306
	T76/ø150/clay	9899702743
	T76/ø175/clay	9899702744
	T76/ø200/EXX	9899703307
	T76/ø200/clay	9899702750
	T76/ø120/ESS-F	9899700093



## Minova MAI T111 Value line

HOLLOW BARS				
Item	Type	Length (other lengths on request)		
		2m	3m	4m
Hollow bars bright	T111L	9899701772	9899701773	9899701774
	T111N	9899701767	9899701768	9899701769
Hollow bars galvanized	T111L	9899710169	9899702687	9899710170
	T111N	9899710171	9899702688	9899710172
Hollow bars TwinCoat	T111L	9899710572	9899710438	9899710566
	T111N	9899710573	9899710565	9899710567

COMPONENTS			
Item	Type	Micropiles	
Couplers bright	T111, L=250mm	9899701777	
Couplers galvanized	T111, L=250mm	9899702690	
Couplers TwinCoat	T111, L=250mm	9899710568	
Nuts bright	Load bearing	9899701778	
	Lock nut	9899711192	
Nuts galvanized	Load bearing	9899702692	
Plates bright	T111L flat 300 x 300 x 80, ø130mm, with chamfer	9899702098	
	T111N flat 350 x 350 x 90, ø130mm, with chamfer	9899702099	
Plates galvanized	T111L flat 300 x 300 x 80, ø130mm, with chamfer	9899703289	
	T111N flat 350 x 350 x 90, ø130mm, with chamfer	9899703290	

DRILL BITS			
Item	Type (other types on request)	Micropiles	
Drill bits	T111/ø175/XX	9899710294	
	T111/ø220/EX-4	9899701780	
	T111/ø220/EX-5	9899702412	
	T111/ø220/clay	9899701779	
	T111/ø170/ESS-F	9899701781	

## Technical Data of the approved systems

PRODUCT SPECIFICATION AND CHARACTERISTIC LOAD-BEARING CAPACITIES OF THE HOLLOW BAR SYSTEM																
Line	Parameter	Type R								Type T						
		R25	R32L	R32N	R32S	R38N	R51L	R51N	T51S	T63N	T76N	T76S	T111L	T111N		
1	Nominal diameter $D_{a, nom}$	mm	25	32	32	32	38	51	51	51	63	76	76	111	111	
2	Outer diameter $D_a$	mm	24.7	31.3	31.3	31.3	38.0	50.0	50.0	51.9	64.9	75.4	75.4	111.0	111.0	
3	Inner diameter $D_{i1}$	mm	14.0	20.6	18.5	15.0	19.0	33.3	30.2	26.6	40.6	51.0	44.0	85.0	75.5	
4	Nominal cross sectional area $S_0^{2)}$	mm <sup>2</sup>	300	350	430	520	750	900	1070	1325	1720	1870	2400	3185	4395	
5	Nominal mass $m^{3)}$	kg/m	2.35	2.75	3.4	4.1	5.9	7.05	8.4	10.4	13.5	14.7	18.85	25.0	34.5	
6	Relative rib area $f_R$	-	0.12								0.24					
7	Nominal yield load $F_{p0.2, nom}$	kN	150	160	230	280	400	450	630	750	900	1200	1500	2000	2750	
8	Nominal tensile load-bearing capacity $F_{m, nom}^{4)}$	kN	200	210	280	360	500	550	800	1050	1400	1600	1900	2640	3650	
9	Yield strength $R_{p0.2}^{5)}$	N/mm <sup>2</sup>	500	460	530	530	530	500	590	570	520	640	630	630	630	
10	Tensile strength $R_m^{5)}$	N/mm <sup>2</sup>	670	600	650	690	660	610	750	790	810	860	790	830	830	
11	$R_m / R_{p0.2}^{6)}$	-	≥1.15													
12	Total elongation at maximum load $A_{gt}$	%	≥2.5												≥5.0	
13	Fatigue strength $2 \times \sigma_a^{7)}$	N/mm <sup>2</sup>	≥120								≥100					
14	Notch effect according to EN 1993-1-9	N/mm <sup>2</sup>	90								70					
15	Bond strength $t_{ak}^{8)}$	N/mm <sup>2</sup>	≥2.8								≥5.3					
16	Moment of inertia $I^{9)}$	mm <sup>4</sup>	11 200	25 800	29 800	33 300	75 700	179 000	211 000	215 000	480 000	863 000	977 000	3 580 000	4 110 000	
17	Thread	-	ISO 10208				ISO 1720				Factory Standard					

### Legend

- <sup>1)</sup> Mean value
- <sup>2)</sup> Calculated based on nominal mass  $m$ ,  $S_0 = 10^3 \times m / 7.85$
- <sup>3)</sup> Allowable deviation - 3% to + 9%
- <sup>4)</sup> Characteristic value as 5% fractile
- <sup>5)</sup> Calculated based on nominal force and nominal cross sectional area, rounded value
- <sup>6)</sup> Characteristic value as 10% fractile

- <sup>7)</sup> Determined at an upper load of  $F_{up} = 0.7 \times F_{p0.2, nom}$  for the hollow bar, coupler and anchorage 80 N/mm<sup>2</sup>
- <sup>8)</sup> Characteristic value, determined in pull-out tests. The values are based on a mean value with a slip of 0.01, 0.1 and 1.0 mm and a cylinder compressive strength of cement grout of ≥40 N/mm<sup>2</sup>
- <sup>9)</sup> Determined in bending test. Relative to a modulus of elasticity of 205 000 N/mm<sup>2</sup> and reduction by 5% to take into account deviations in the mass tolerances

Modulus of elasticity  $E \approx 205\,000\text{ N/mm}^2$

# SELF DRILLING ACCESSORIES.

We offer a suite of complimentary products to address your bolting needs.



## SACRIFICIAL DRILL BITS & ADAPTERS

The correct selection of the drill bit dependent on the geological conditions on site is essential to ensuring a productive and cost-effective installation of the hollow bars. Conventional drill bits are designed for longevity. We offer a wide range of drill bits suitable for diverse geological conditions.

Drill bit adapters increase flexibility by allowing the use of drill bits designed for other dimensions of hollow bars.



## SPACERS OR CENTRALISERS

Spacers are used to centre the hollow bars within the borehole and to ensure the correct grout cover of the load-bearing element according to the relevant standards and as specified in the approvals.



## GROUT SWIVELS

The grout swivels consist of a grout body and a swivel shaft and are attached to the shank adapter. The grout swivels are suitable for simultaneous drilling and grouting.

## DRILL BITS REQUIREMENTS

The stability of the drill bits enables safe drilling of the borehole down to the required depth

Since the drill bit is used for one borehole only (sacrificial drill bit), the service life should meet but not significantly exceed the requirements so as to ensure cost-effectiveness)

The type of drill bit used and, in particular, the inserts are dependent on the geological conditions on site

The drill bit diameter is dependent on the design requirements and the specifications defined in the approvals

## ADVANTAGES

Help to ensure correct grout cover according to specification

## ADVANTAGES

Suitable for simultaneous drilling and grouting

Available for all standard types of shank adapters



## COUPLING BOXES

Coupling boxes (crossover couplers) must be installed between the shank adapter and the hollow bar during the drilling operation. Since this section of the drill string is directly and continuously subjected to the impact energy of the drill hammer, our coupling boxes are manufactured from hardened steel and are intended for multiple uses.

## ADVANTAGES

Centre stop feature to ensure direct transfer of the impact energy to the face of the hollow bar

Flats feature for loosening of the connection.



## PULL TEST EQUIPMENT

A CE-approved pull tester is available to test the self-drilling nails and piles after installation of the system and curing of the grout body.

## ADVANTAGES

CE- approved



## MAI M400NT PUMP

We recommend the use of the M400NT grout pump to produce a grout mixture with a controlled water/cement ratio.

The M400NT pump is globally the most widely used pump in tunnel construction.

## ADVANTAGES

Proven technology for a long service life

Easy handling and maintenance

User-friendly operation

Robust design



## MAI M440GE PUMP

For geotechnical applications, we recommend the M440GE pump to produce a grout mixture with a controlled water/cement ratio.

The M440GE grout pump is the result of decades of experience and sets new standards in process security.

## ADVANTAGES

Multi-purpose machine

Intelligent control system

Innovative water and dry material management

## Accessories

GROUT SWIVELS		
Item	Type	Part number
MAI-swivel body ø75mm	R25	9899702502
MAI-swivel shaft ø75mm box R28/box R25	R25	9899702988
MAI-swivel shaft ø75mm box R32/box R25	R25	9899702990
MAI-body seal kit ø75mm (4pcs)	R25	9899702503
MAI-swivel body ø75mm	R32	9899702502
MAI-swivel body ø100mm	R32	9899702529
MAI-swivel shaft ø75mm box R28/box R32	R32	9899702989
MAI-swivel shaft ø75mm box R32/box R32	R32	9899702618
MAI-swivel shaft ø75mm box T38/box R32	R32	9899702498
MAI-swivel shaft ø75mm box R38/box R32	R32	9899702619
MAI-swivel shaft ø75mm box T45/box R32	R32	9899702622
MAI-swivel shaft ø100mm box T51/box R32	R32	9899702624
MAI-swivel shaft ø100mm box H55/box R32	R32	9899702496
MAI-body seal kit ø75mm (4pcs)	R32	9899702503
MAI-body seal kit ø100mm (4pcs)	R32	9899702530
MAI-anchor seal R32	R32	9899702510
MAI-swivel body ø75mm	R38	9899702502
MAI-swivel body ø100mm	R38	9899702529
MAI-swivel shaft ø75mm box R32/box R38	R38	9899703039
MAI-swivel shaft ø75mm box T35/box R38	R38	9899711114
MAI-swivel shaft ø75mm box T38/box R38	R38	9899702499
MAI-swivel shaft ø75mm box R38/box R38	R38	9899702620
MAI-swivel shaft ø75mm box T45/box R38	R38	9899702500
MAI-swivel shaft ø100mm box T51/box R38	R38	9899702625
MAI-swivel shaft ø100mm box H55/box R38	R38	9899702517
MAI-body seal kit ø75mm (4pcs)	R38	9899702503
MAI-body seal kit ø100mm (4pcs)	R38	9899702530
MAI-anchor seal R38	R38	9899702511
MAI-swivel body ø75mm	R51	9899702502
MAI-swivel body ø100mm	R51	9899702529
MAI-swivel body ø120mm	R51	9899702232
MAI-swivel shaft ø100mm box T38/box R51	R51	9899702623
MAI-swivel shaft ø100mm box R38/box R51	R51	9899710374
MAI-swivel shaft ø100mm box T45/box R51	R51	9899702501
MAI-swivel shaft ø75mm box T45/box R51	R51	9899710722
MAI-swivel shaft ø100mm box T51/box R51	R51	9899702626
MAI-swivel shaft ø100mm box R51/box R51	R51	9899702647
MAI-swivel shaft ø100mm box H55/box R51	R51	9899702497
MAI-swivel shaft ø120mm box C64/box R51	R51	9899711151

## Accessories







GROUT SWIVELS (CONTINUED)		
Item	Type	Part number
MAI-swivel shaft ø120mm box C90/box R51	R51	9899702627
MAI-body seal kit ø75mm (4pcs)	R51	9899702503
MAI-body seal kit ø100mm (4pcs)	R51	9899702530
MAI-body seal kit ø120mm (4pcs)	R51	9899702506
MAI-anchor seal R51	R51	9899702512
MAI-swivel body ø100mm	T51	9899702529
MAI-swivel shaft ø100mm box T38/box T51	T51	9899711345
MAI-swivel shaft ø100mm box T45/box T51	T51	9899711346
MAI-swivel shaft ø100mm box R51/box T51	T51	9899711347
MAI-swivel shaft ø100mm box T51/box T51	T51	9899711348
MAI-swivel shaft ø100mm box H55/box T51	T51	9899710937
MAI-body seal kit ø100mm (4pcs)	T51	9899702530
MAI-anchor seal T51	T51	9899711355
MAI-swivel body ø100mm	T63	9899702529
MAI-swivel shaft ø100mm box T38/box T63	T63	9899711350
MAI-swivel shaft ø100mm box T45/box T63	T63	9899711351
MAI-swivel shaft ø100mm box R51/box T63	T63	9899711352
MAI-swivel shaft ø100mm box T51/box T63	T63	9899711353
MAI-swivel shaft ø100mm box H55/box T63	T63	9899711354
MAI-body seal kit ø100mm (4pcs)	T63	9899702530
MAI-anchor seal T63	T63	9899711356
MAI-swivel body ø120mm	T76	9899702232
MAI-swivel shaft ø120mm box H90/box T76	T76	9899702249
MAI-swivel shaft ø120mm box H55/box T76	T76	9899702742
MAI-body seal kit ø120mm (4pcs)	T76	9899702506
MAI-anchor seal T76	T76	9899702509
MAI-swivel body ø150mm	T111	9899702272
MAI-swivel shaft ø150mm box H90/box T111	T111	9899702273
MAI-body seal kit ø150mm (4pcs)	T111	9899702505
MAI-anchor seal T111	T111	9899702274

## Accessories

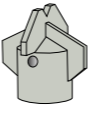
COUPLING BOXES		
Item	Type	Part number
MAI-coupling box R25-R25 with middle stop L=200mm	R25	9899101829
MAI-coupling box T38-R25 with middle stop L=200mm	R25	9899700103
MAI-coupling box R25-R32 with middle stop L=200mm	R32	9899101830
MAI-coupling box R32-R32 with middle stop L=200mm	R32	9899101831
MAI-coupling box T38-R32 with middle stop L=200mm	R32	9899700075
MAI-coupling box T45-R32 with middle stop L=205mm	R32	9899150137
MAI-coupling box R25-R38 with middle stop L=200mm	R38	9899102702
MAI-coupling box R32-R38 with middle stop L=200mm	R38	9899101832
MAI-coupling box R38-R38 with middle stop L=200mm	R38	9899102494
MAI-coupling box R51-R38 with middle stop L=235mm	R38	9899150026
MAI-coupling box T38-R38 with middle stop L=205mm	R38	9899151588
MAI-coupling box T45-R38 with middle stop L=205mm	R38	9899151059
MAI-coupling box T51-R38 with middle stop L=235mm	R38	9899710916
MAI-coupling box T38-R51 with middle stop L=235mm	R51	9899150025
MAI-coupling box T45-R51 with middle stop L=235mm	R51	9899150027
MAI-coupling box T51-R51 with middle stop L=235mm	R51	9899702740
MAI-coupling box R38-T51 with middle stop L=220mm	T51	9899711234
MAI-coupling box R51-T51 with middle stop L=220mm	T51	9899711324
MAI-coupling box T45-T51 with middle stop L=220mm	T51	9899711335
MAI-coupling box T51-T51 with middle stop L=220mm	T51	9899711336
MAI-coupling box T38-T51 with middle stop L=220mm	T51	9899711331
MAI-coupling box R51-T63 with middle stop L=220mm	T63	9899711342
MAI-coupling box T38-T63 with middle stop L=220mm	T63	9899711339
MAI-coupling box T45-T63 with middle stop L=220mm	T63	9899711340
MAI-coupling box T51-T63 with middle stop L=220mm	T63	9899711341
MAI-coupling box H55-T76 with middle stop L=220mm	T76	9899151829
MAI-coupling box R38-T76 with middle stop L=220mm	T76	9899700004
MAI-coupling box R51-T76 with middle stop L=220mm	T76	9899711068
MAI-coupling box T38-T76 with middle stop L=220mm	T76	9899701484
MAI-coupling box T45-T76 with middle stop L=220mm	T76	9899701789
MAI-coupling box T51-T76 with middle stop L=220mm	T76	9899702644

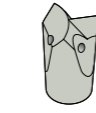
Please note that the left value of the description refers to the thread of the shank, which does not fit the thread of the bolt.

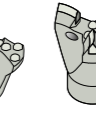
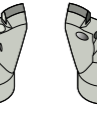
## Accessories

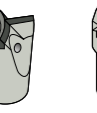
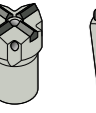
DRILL BITS											
Bit shape											
Bit type	Clay Bit	XX	EX	EC	ES-F	ES-D	EY	EYY	ECC	EXX	ESS-F

DRILL BIT ADAPTERS		
Item		Part number
MAI-drill bit adapter R32/R25		9899151091
MAI-drill bit adapter R38/R32		9899150008
MAI-drill bit adapter R51/R38		9899151092
MAI-drill bit adapter R51/T51		9899710500
MAI-drill bit adapter T63/T76		9899711195

INJECTION ADAPTERS		
Item	Type	Part number
MAI-injection adapter R25/1"	R25	9899102514
MAI-injection adapter R32/1"	R32	9899101952
MAI-injection adapter R38/1"	R38	9899102542
MAI-injection adapter R51/1"	R51	9899150067
MAI-injection adapter T51/1"	T51	9899711343
MAI-injection adapter T63/1"	T63	9899711344
MAI-injection adapter T76/ 6/4"	T76	9899151830

PULL TESTER		
Item		Part number
MAI-pulltester SDA manual hydraulic 300kN complete		9899710812

**Minova MAI GmbH**

Werkstrasse 17

9710 Feistritz/Drau, Austria

T. +43 4245 65166 0

F. +43 42 45 65166 800

[info.at@minovaglobal.com](mailto:info.at@minovaglobal.com)

[minovaglobal.com](http://minovaglobal.com)

